

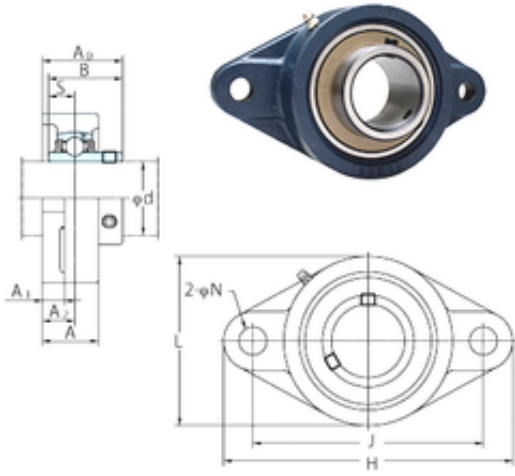

BEARING CORP.OF CANADA LTD.

FYH UCFL211-32E Bearing units

Bearing No. UCFL211-32E



UCFL211-32E Bearing 2D drawings and 3D CAD models

Bore Diameter	50,8 mm
d	50,8 mm
A0	58,4 mm
A	43 mm
A1	18 mm
B	55,6 mm
H	224 mm
J	184 mm
L	130 mm
N	16,5 mm
S	22,2 mm
A2	25 mm
Weight	3,3 Kg
Basic dynamic load rating (C)	43,4 kN
Basic static load rating (C0)	29,4 kN